



















LEGEND

 SPRING CHECK VALVE  REDUCED PRESSURE BACKFLOW DEVICE  BACKWATER VALVE  BALL VALVE  DIVERTER VALVE  BYPASS VALVE  MOTORIZED VALVE	 TANK LEVEL SENSOR SUBMERSIBLE  PRESSURE GAUGE  PRESSURE TRANSMITTER  FLOW METER	 AIR-GAP BACKFLOW PREVENTER  TANK VENT  PRESSURE TANK, 80 GALL.  SUBMERSIBLE PUMP  AIR BLOWER	 EFFLUENT FILTER, 1588 MICRON  SEDIMENT FILTER 100 MICRON  AIR DIFFUSER
--	---	--	--

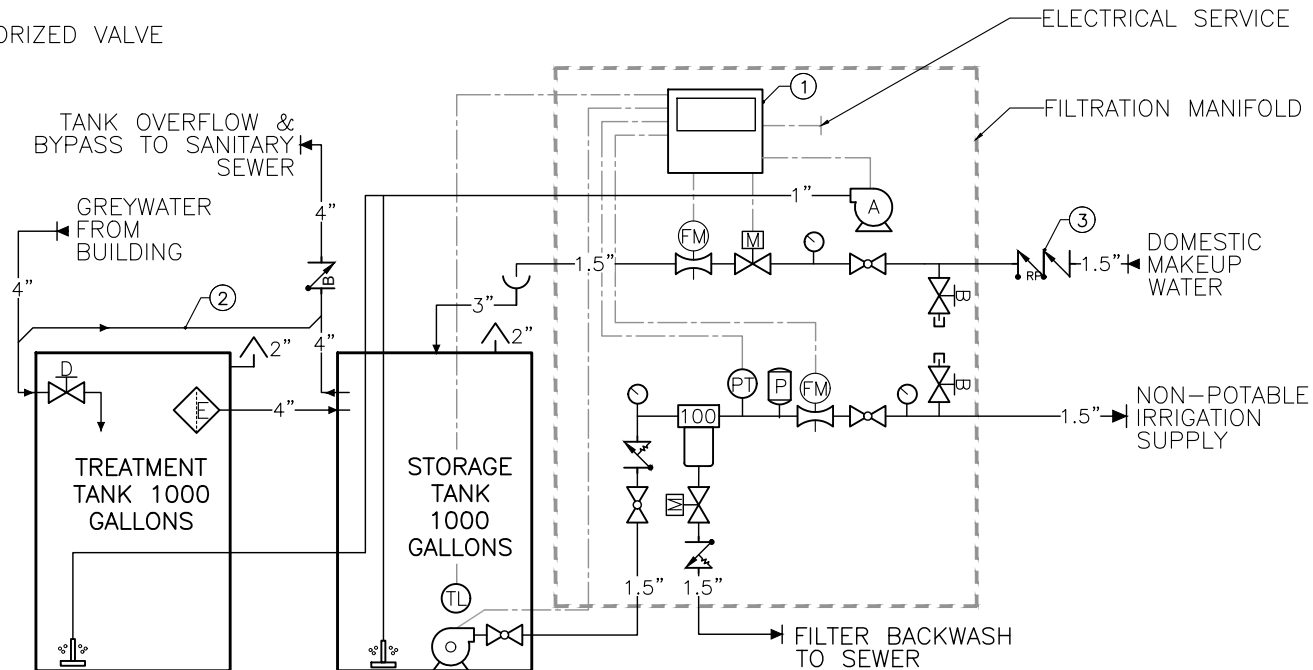

SYSTEM SPECIFICATIONS

GREY WATER SYSTEM	WATERLAB GWC-1000U-20
TREATMENT CAPACITY	1000 GPD
FINAL FILTRATION	100 MICRON
SUPPLY PRESSURE & FLOW	20 GPM @ 50 PSI
GREY WATER SUPPLY	SUB-SURFACE IRRIGATION (DRIP OR BUBBLERS)
ELECTRICAL SERVICE	208-230V 3-PHASE 15A

SYSTEM NOTES

- ① GREY WATER SYSTEM CONTROL PANEL
- ② BYPASS TO SEWER WHEN DIVERTER VALVE IS CLOSED
- ③ INSTALL REDUCED PRESSURE BACKFLOW DEVICE ON MAKEUP WATER SUPPLY, BY OTHERS



**Commercial Greywater System
GWC-1000U-20**

DRAWING NAME:

GREY WATER DIAGRAM

DATE:

5/28/2016

DRAWN:

JM

SCALE:

NO SCALE

SHEET:

1 of 4

UNLESS NOTED DIMENSIONS ARE IN INCHES
WITH TOLERANCES ±0.02 IN/IN
DO NOT SCALE

WATERLAB IS THE PRODUCTS DIVISION OF
WATERSPROUT INC. THE INFORMATION
CONTAINED IN THIS DRAWING IS THE SOLE
PROPERTY OF WATERSPROUT INC. ANY
REPRODUCTION IN PART OR AS A WHOLE
WITHOUT THE WRITTEN PERMISSION OF
WATERSPROUT INC IS PROHIBITED. DESIGN AND
INVENTIONS RIGHTS ARE RESERVED. IN THE
INTEREST OF TECHNOLOGICAL ADVANCEMENT,
ALL PRODUCTS ARE SUBJECT TO DESIGN
AND/OR MATERIAL CHANGE WITHOUT NOTICE
WATERSPROUT INC. 2016

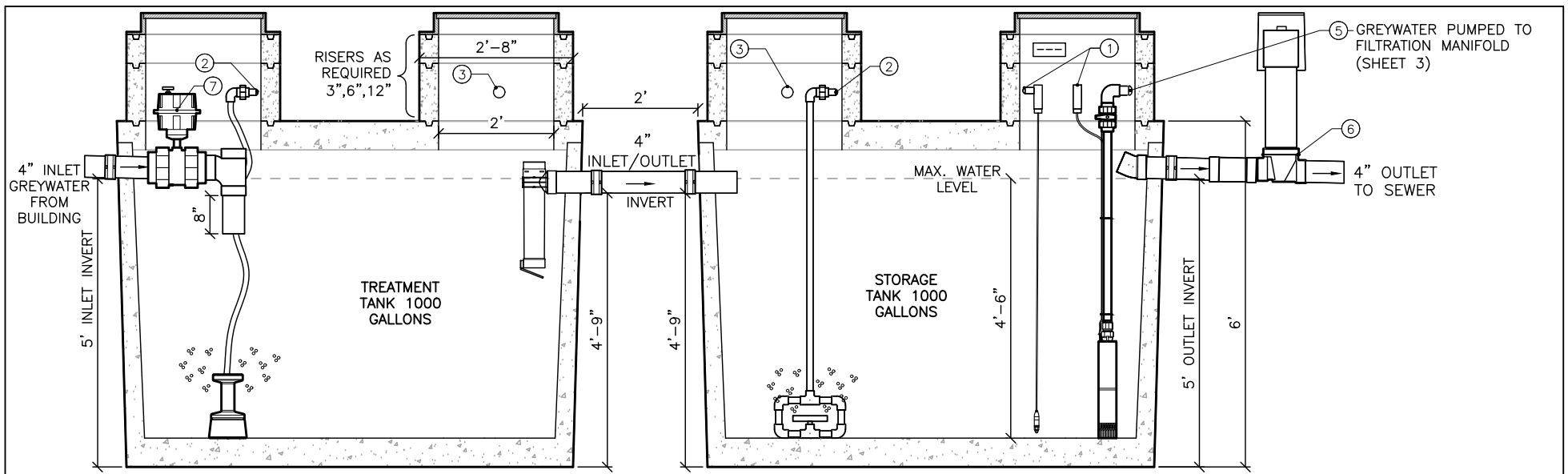

SECTION A-A

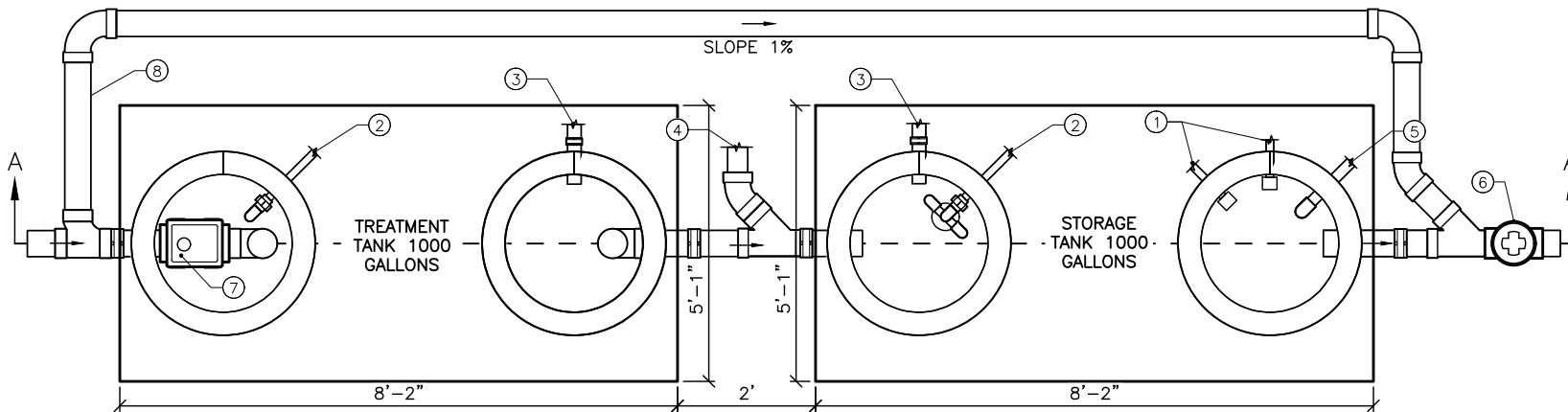

TREATMENT & STORAGE TANK PLAN

TANK NOTES

①	LINE & LOW VOLTAGE CONDUIT TO FILTRATION MANIFOLD
②	BLOWER SUPPLY FROM FILTRATION MANIFOLD, 1"Ø PVC FROM MANIFOLD IF LESS THAN 300'.
③	TANK VENT PLUMBED TO BUILDING SANITARY VENT, 2"Ø
④	DOMESTIC MAKEUP WATER FROM AIR GAP (SHEET 3), 3"Ø
⑤	TREATED GREYWATER PUMPED TO FILTRATION MANIFOLD (SHEET 3), 1.5"Ø
⑥	BACKWATER VALVE ON TANK OVERFLOW, 4"Ø. VALVE BOX AT GRADE.
⑦	DIVERTER VALVE WITH ACTUATOR ON TANK INLET, 4"Ø
⑧	BYPASS PIPING TO SEWER, 4"Ø

GENERAL NOTES

1. THE CONTRACTOR SHALL FURNISH AND INSTALL THE GREYWATER SYSTEM PACKAGE AS PROVIDED BY WATERSPROUT INC. ALL PIPING & EQUIPMENT BETWEEN TANKS, FILTRATION MANIFOLD & BUILDING SHALL BE SUPPLIED BY INSTALLING CONTRACTOR. SEE SPECIFICATION ON SHEET 4 FOR SPECIFIC EQUIPMENT INCLUDED IN PACKAGE.
2. ALL WORK ASSOCIATED WITH GREYWATER SYSTEM SHALL CONFORM TO ALL COUNTY, STATE AND LOCAL PLUMBING & ELECTRICAL CODES.
3. PRE-CAST CONCRETE TREATMENT & STORAGE TANK SHOWN ARE GENERALLY AVAILABLE IN WESTERN STATES. TANK DIMENSIONS & CAPACITIES MAY VARY BASED UPON LOCAL MANUFACTURERS AND STOCK. CONTACT WATERSPROUT FOR AVAILABILITY.



**Commercial Greywater System
GWC-1000U-20**

DRAWING NAME:
GREYWATER TANKS

DATE: 5/28/2016	DRAWN: JM
SCALE: NO SCALE	SHEET: 2 of 4

UNLESS NOTED DIMENSIONS ARE IN INCHES WITH TOLERANCES ±0.02 IN/IN DO NOT SCALE

WATERLAB IS THE PRODUCTS DIVISION OF WATERSPROUT INC. THE INFORMATION CONTAINED IN THIS DRAWING IS THE SOLE PROPERTY OF WATERSPROUT INC. ANY REPRODUCTION IN PART OR AS A WHOLE WITHOUT THE WRITTEN PERMISSION OF WATERSPROUT INC IS PROHIBITED. DESIGN AND INVENTIONS RIGHTS ARE RESERVED. IN THE INTEREST OF TECHNOLOGICAL ADVANCEMENT, ALL PRODUCTS ARE SUBJECT TO DESIGN AND/OR MATERIAL CHANGE WITHOUT NOTICE WATERSPROUT INC. 2016

SPECIFICATIONS	
DIMENSIONS	3'-2" WIDE x 2'-0" DEEP x 6'-0" TALL
WEIGHT	320 LBS.
FINAL FILTRATION	100 MICRON
PRESSURE RATING	150 PSI
SUPPLY PRESSURE & FLOW	50 PSI MIN. @ 20 GPM MAX.
GREYWATER PROCESSED	1000 GPD WITH ADDITIONAL WATER SUPPLIED BY MAKEUP
GREYWATER SUPPLY	SUB-SURFACE IRRIGATION (DRIP, BUBBLERS, ETC.)
MAKEUP BACKFLOW PREVENTER	AIR-GAP
ELECTRICAL	
ELECTRICAL SERVICE	208-230V 3-PHASE CIRCUIT 15A
PUMP	1 HP, 220VAC SINGLE PHASE 6.4A
CONTROL PANEL	120VAC 2A
AIR BLOWER	120VAC 0.6A
SUBMERSIBLE PRESSURE TRANSMITTER	24VDC 4-20mA

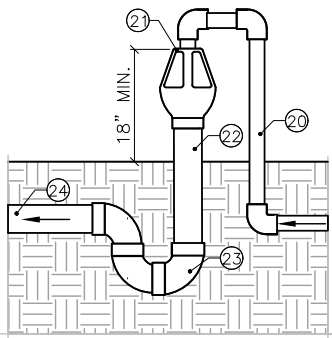

AIR-GAP BACKFLOW PREVENTER

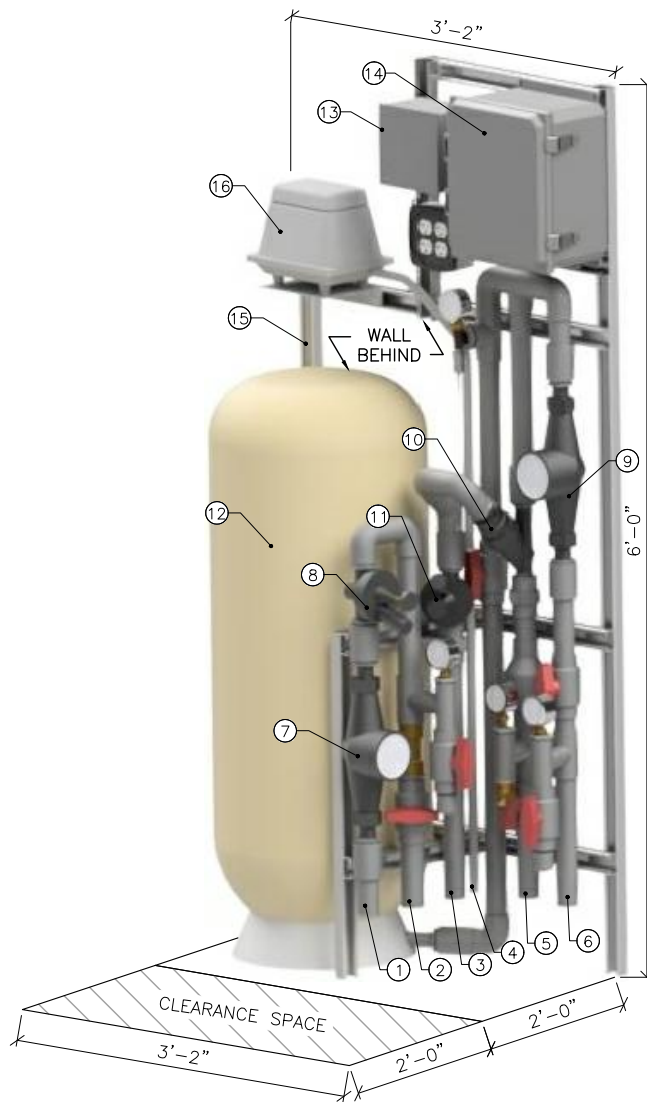

FILTRATION MANIFOLD

MANIFOLD NOTES	
①	MAKEUP WATER TO STORAGE TANK (VIA AIR-GAP), 1.5"Ø PVC SCH.80
②	MAKEUP WATER IN FROM DOMESTIC SUPPLY, 1.5"Ø PVC SCH.80
③	FILTER BACKFLUSH WATER, 1.5"Ø, PVC SCH.80. DIRECT CONNECT TO SEWER PIPE 3"Ø MIN.
④	BLOWER SUPPLY LINE TO TANK, 1"Ø, PVC SCH.80
⑤	GREYWATER IN FROM PUMP, 1.5" PVC SCH.80
⑥	IRRIGATION SUPPLY OUT, 1.5" PVC SCH.80
⑦	MAKEUP WATER METER
⑧	MAKEUP VALVE
⑨	IRRIGATION WATER METER
⑩	SEDIMENT FILTER, 100 MICRON
⑪	FILTER BACKWASH VALVE
⑫	PRESSURE TANK 80 GALLON
⑬	ELECTRICAL SERVICE CONNECTION
⑭	SYSTEM CONTROL PANEL
⑮	MANIFOLD STEEL SUPPORT FRAME, ATTACH TO WALL
⑯	AIR BLOWER
AIR-GAP NOTES	
⑳	MAKEUP WATER FROM MANIFOLD, 1.5"Ø, SCH.80 PVC ABOVE GROUND
㉑	AIR-GAP BACKFLOW PREVENTER, 3" FPT
㉒	3"Ø SCH.80 STAND PIPE WITH 3"MALE ADAPTER SCH.80 PVC
㉓	P-TRAP 3"Ø, SCH.40 PVC OR ABS
㉔	DRAIN TO STORAGE TANK, 3"Ø, SLOPE 1% MIN. SCH.40 PVC OR ABS

GENERAL NOTES

1. THE FILTRATION MANIFOLD SHALL BE PRE-PLUMBED, WIRED, AND TESTED PRIOR TO SHIPMENT. THE MANIFOLD IS DELIVERED AS A TURNKEY SYSTEM TO PROJECT SITE. ALL PIPING AND FITTINGS SHALL BE SCHEDULE 80 PVC.
2. THE FILTRATION MANIFOLD SHALL BE INSTALLED IN A LOCATION WHERE IT IS PROTECTED FROM THE ELEMENTS, FREEZING CONDITIONS, AND VANDALISM. CONTACT FACTORY FOR OPTIONAL FREESTANDING ENCLOSURES. THE MANIFOLD MAY BE INSTALLED INDOORS, IN A MECHANICAL ROOM OR OTHER LOCATION, WITH A FLOOR DRAIN SO AS TO DRAIN AWAY ANY INCIDENTAL WATER PRODUCED DURING THE INSTALLATION, OPERATION AND MAINTENANCE OF THE MANIFOLD.
3. THE MANIFOLD IS FREESTANDING WITH STEEL SUPPORT FRAME. THE FRAME SHALL BE ATTACHED TO A WALL TO PREVENT MOVEMENT. THE PRESSURE TANK IS MOUNTED TO THE FRAME BUT SHOULD ALSO BE FULLY SUPPORTED BY THE GROUND UNDERNEATH.
4. PUMP IN STORAGE TANK MUST BE LOCATED NOT LOWER THAN 10' VERTICAL FEET FROM BOTTOM OF FILTRATION MANIFOLD TO PROVIDE RATED PRESSURE AND SUPPLY. CONSULT FACTORY FOR DISTANCES GREATER THAN 10'.
5. ALL WORK ASSOCIATED WITH GREYWATER SYSTEM SHALL CONFORM TO ALL COUNTY, STATE AND LOCAL PLUMBING & ELECTRICAL CODES.



**Commercial Greywater System
GWC-1000U-20**

DRAWING NAME:
GREYWATER MANIFOLD & AIR GAP

DATE: 5/28/2016	DRAWN: JM
SCALE: NO SCALE	SHEET: 3 of 4

UNLESS NOTED DIMENSIONS ARE IN INCHES WITH TOLERANCES ±0.02 IN/IN DO NOT SCALE

WATERLAB IS THE PRODUCTS DIVISION OF WATERSPROUT INC. THE INFORMATION CONTAINED IN THIS DRAWING IS THE SOLE PROPERTY OF WATERSPROUT INC. ANY REPRODUCTION IN PART OR AS A WHOLE WITHOUT THE WRITTEN PERMISSION OF WATERSPROUT INC IS PROHIBITED. DESIGN AND INVENTIONS RIGHTS ARE RESERVED. IN THE INTEREST OF TECHNOLOGICAL ADVANCEMENT, ALL PRODUCTS ARE SUBJECT TO DESIGN AND/OR MATERIAL CHANGE WITHOUT NOTICE WATERSPROUT INC. 2016

SPECIFICATIONS FOR WATERLAB GWC-1000U-20 COMMERCIAL GREYWATER SYSTEM

1. GENERAL

THE CONTRACTOR SHALL FURNISH AND INSTALL A WATERLAB GWC-1000U-20 GREYWATER SYSTEM PACKAGE AS MANUFACTURED BY WATERSPROUT INC. THE GREYWATER SYSTEM PACKAGE SHALL BE COMPLETE WITH ALL NEEDED EQUIPMENT AS SHOWN ON THE DRAWINGS AND SPECIFIED HEREIN. THE PRINCIPAL ITEMS OF EQUIPMENT SUPPLIED BY WATERSPROUT INC SHALL INCLUDE: (1) ONE TREATMENT TANK AND ONE STORAGE TANK EACH WITH A MINIMUM VOLUME OF 1,000 GALLONS (3785L). (2) ALL PUMPS, CONTROLS, AERATORS, VALVES, SANTEE FILTERS, AND FITTINGS INTERIOR TO THE TANKS AS SHOWN ON THE DRAWINGS. (3) THE FILTRATION MANIFOLD WITH BLOWER SHALL BE PROVIDED BY WATERSPROUT INC AS A MANUFACTURED TURNKEY SYSTEM. (4) MAKEUP WATER AIR-GAP ASSEMBLY. (5) BACKWATER VALVE WITH ACCESSORIES. ALL OTHER ITEMS SHALL BE PROVIDED BY INSTALLING CONTRACTOR.

2. DESIGN CONDITIONS

THE GWC-1000U-20 GREYWATER SYSTEM SHALL BE CAPABLE OF SUPPLYING UP TO 1000 GPD OF FILTERED GREYWATER TO THE IRRIGATION SYSTEM, WITH ADDITIONAL WATER SUPPLIED BY MAKEUP WATER ADDED TO THE STORAGE TANK THROUGH AN AIR-GAP BACKFLOW PREVENTER. GREYWATER COLLECTED FROM THE BUILDING SHALL INCLUDE SHOWER, SINK AND LAUNDRY WATER. TOILETS AND KITCHEN SINK WASTE ARE CLASSIFIED AS BLACKWATER AND CANNOT BE PROCESSED BY THE GREYWATER SYSTEM. THE FILTRATION MANIFOLD SHALL FILTER GREYWATER TO A 100 MICRON SIZE AND SUPPLY GREYWATER TO THE LANDSCAPE IRRIGATION SYSTEM WITH A MINIMUM PRESSURE OF 50 PSI AT A MAXIMUM FLOW RATE OF 20 GPM. THE GWC-1000U-20 IS CLASSIFIED AS AN 'UNTREATED' SYSTEM PER CALIFORNIA PLUMBING CODE AND MUST BE APPLIED THROUGH SUB-SURFACE IRRIGATION METHODS ONLY (DRIP, BUBBLERS, ETC.). CONSULT LOCAL CODES & REGULATIONS.

3. COLLECTION & DIVERSION

GREYWATER FROM THE BUILDING SHALL DRAIN TO THE UNDERGROUND TREATMENT TANK. A BYPASS FITTING & PIPING SHALL BE INSTALLED ON THE INLET TO THE TREATMENT TANK AND CONNECTED TO THE TANK OVERFLOW. THE BYPASS PIPING SHALL INITIALLY BE RAISED 4" HIGHER THAN THE INLET INVERT TO ALLOW A 1% SLOPE OF THE BYPASS PIPING TO THE TANK OVERFLOW. A BYPASS DIVERTER VALVE SHALL BE INSTALLED ON THE TANK INLET, INTERIOR TO THE TANK, TO ALLOW DIVERSION OF GREYWATER THROUGH BYPASS PIPING.

4. TREATMENT TANK

AFTER DRAINING THROUGH THE DIVERTER VALVE THE GREYWATER SHALL ENTER THE TREATMENT TANK THROUGH A SANTEE FITTING. THE TANK SHALL TOTAL 1000 GALLONS OF STORAGE MINIMUM. TANK DIMENSIONS AND MATERIAL CAN VARY BASED UPON LOCAL AVAILABILITY. TREATMENT OF GREYWATER IN TREATMENT TANK INCLUDES SETTLING OF LARGE SOLIDS, AERATION OF GREYWATER TO ELIMINATE ODOR AND PROMOTE MICROBIAL DECOMPOSITION OF ORGANIC MATTER, AND MECHANICAL FILTRATION. AN AIR DIFFUSER LOCATED AT THE BOTTOM OF THE TANK SHALL OXYGENATE GREYWATER. GREYWATER SHALL OVERFLOW THE TREATMENT TANK THROUGH A 4" EFFLUENT FILTER WITH 1/16" SCREEN SIZE (1588 MICRON) FITTED WITH A GAS DEFLECTOR.

5. STORAGE TANK

GREYWATER OVERFLOWING THE TREATMENT TANK SHALL ENTER THE STORAGE TANK. THE TANK SHALL TOTAL 1000 GALLONS OF STORAGE MINIMUM. TANK DIMENSIONS AND MATERIAL CAN VARY BASED UPON LOCAL AVAILABILITY. AN AIR DIFFUSER AT BOTTOM OF TANK SHALL OXYGENATE GREYWATER IN THE STORAGE TANK THROUGH A 1" PVC RIGID PIPE. THE STORAGE TANK SHALL HAVE A GRAVITY OVERFLOW DRAIN CONNECTED TO THE SEWER. THE OVERFLOW SHALL HAVE A BACKWATER VALVE TO PREVENT SEWER BACKFLOW INTO THE TANK. THE BACKFLOW VALVE SHALL REMAIN ACCESSIBLE THROUGH A DEEP BURY KIT AND 12" ACCESS BOX AT GRADE.

6. WATER LEVEL MONITORING & PRESSURIZATION

WATER LEVEL IN THE STORAGE TANK SHALL BE MONITORED BY A SUBMERSIBLE PRESSURE TRANSMITTER PROVIDING CONTINUOUS LEVEL INFORMATION TO THE CONTROL PANEL LOCATED ON THE FILTRATION MANIFOLD. A SINGLE SUBMERSIBLE IRRIGATION PUMP LOCATED IN THE STORAGE TANK SHALL PROVIDE PRESSURIZED GREYWATER TO THE FILTRATION MANIFOLD.

7. MAKEUP WATER

MAKEUP WATER SHALL BE ADDED TO THE STORAGE TANK DURING LOW WATER LEVEL CONDITIONS THROUGH AN AIR-GAP BACKFLOW PREVENTER. MAKEUP WATER ADDED TO AIR-GAP BACKFLOW PREVENTER SHALL DRAIN TO THE STORAGE TANK THROUGH 3" Ø DRAIN PIPE SLOPED 1% MIN. THE AIR-GAP MUST BE LOCATED ABOVEGROUND AT EITHER THE FILTRATION MANIFOLD OR BETWEEN THE MANIFOLD AND STORAGE TANK.

8. FILTRATION MANIFOLD

TREATED GREYWATER FROM STORAGE TANK SHALL BE PUMP TO THE FILTRATION MANIFOLD AND SHALL BE MECHANICALLY FILTERED TO 100 MICRON PRIOR TO DISTRIBUTION TO THE IRRIGATION SYSTEM. THE FILTRATION MANIFOLD SHALL BE PRE-PLUMBED, WIRED, AND TESTED PRIOR TO SHIPMENT. ALL PIPING AND FITTINGS SHALL BE SCHEDULE 80 PVC. STORAGE TANK PUMP MUST BE LOCATED NOT LOWER THAN 10' VERTICAL FEET FROM BOTTOM OF FILTRATION MANIFOLD TO PROVIDE RATED PRESSURE AND FLOW. CONSULT FACTORY FOR DISTANCES GREATER THAN 10'. A CONTROL PANEL SHALL BE INCLUDED WITH THE FILTRATION MANIFOLD TO MONITOR AND CONTROL SYSTEM OPERATIONAL PARAMETERS. THE CONTROL SYSTEM SHALL CONTROL TANK LEVELS AND EQUIPMENT OPERATION PER CUSTOM SOFTWARE AND SHALL PROVIDE ALARMS TO MAINTENANCE PROFESSIONALS. AN AIR BLOWER SHALL BE INCLUDED WITH THE FILTRATION MANIFOLD TO PUMP AIR TO THE AIR DIFFUSERS LOCATED IN THE TREATMENT AND STORAGE TANKS. AN IRRIGATION FLOW METER AND MAKEUP FLOW METER SHALL BE INCLUDED WITH THE FILTRATION MANIFOLD AND CONNECTED TO CONTROL PANEL TO METER WATER USAGE. A PRESSURE TRANSMITTER SHALL BE INSTALLED ON THE FILTRATION MANIFOLD AND CONNECTED TO CONTROL PANEL TO MONITOR SYSTEM PRESSURE. AN 80-GALLON BLADDER TANK INCLUDED WITH THE FILTRATION MANIFOLD SHALL MINIMIZE PUMP CYCLING.

9. ELECTRICAL

CONTRACTOR SHALL SUPPLY AND CONNECT (1) 208-230V 3-PHASE CIRCUIT WITH 15 AMP CAPACITY MIN. TO FILTRATION MANIFOLD. ALL CONDUIT AND WIRING TO BE SUPPLIED BY CONTRACTOR. ELECTRICAL LINE VOLTAGE FROM FILTRATION MANIFOLD TO PUMP SHALL BE RATED TO SUPPLY PUMP LOAD: 220VAC SINGE PHASE AT 6.4 AMP, 1 HP. ELECTRICAL LOW VOLTAGE FROM FILTRATION MANIFOLD TO SUBMERSIBLE PRESSURE TRANSMITTER IN STORAGE TANK SHALL BE RATED TO SUPPLY LOAD THROUGH SHIELDED CABLE: 24VDC 4-20mA. ALL WIRING MUST CONFORM TO APPLICABLE CODES.

10. INSTALLATION

INSTALLATION AND CONNECTIONS TO GREYWATER SYSTEM SHALL BE DONE IN ACCORDANCE WITH THE WRITTEN INSTALLATION MANUAL PROVIDED WITH EQUIPMENT BY MANUFACTURER AND IN ACCORDANCE WITH ALL APPLICABLE LOCAL CODES AND REGULATIONS. MANUFACTURER SHALL SUPPLY OPERATIONS & MAINTENANCE MANUAL TO SYSTEM OPERATOR

11. COMMISSIONING, TRAINING AND SUPPORT

WATERSPROUT INC SHALL PROVIDE SERVICES OF QUALIFIED REPRESENTATIVE TO INSPECT INSTALLATION, MAKE ANY NECESSARY ADJUSTMENTS, TEST EQUIPMENT, AND INSTRUCT OPERATING PERSONNEL IN OPERATION AND MAINTENANCE OF GREYWATER SYSTEM EQUIPMENT, AS NEEDED. MANUFACTURER TO PROVIDE SERVICE AND MAINTENANCE SCHEDULE TO CUSTOMER ALONG WITH MAINTENANCE TRAINING AT TIME OF COMMISSIONING, AS NEEDED. SCHEDULED MAINTENANCE OF GREYWATER SYSTEM TO BE PROVIDED BY CUSTOMER.

12. WARRANTY

MANUFACTURER SHALL PROVIDE A WARRANTY ON THE GREYWATER SYSTEM FOR A PERIOD OF ONE YEAR FROM THE COMMISSION DATE OR AFTER SYSTEM DELIVERY, WHICHEVER COMES FIRST, SUBJECT TO THE FOLLOWING CONDITIONS: 1. DURING THE WARRANTY PERIOD, IF ANY PART IS DEFECTIVE OR FAILS TO PERFORM AS SPECIFIED WHEN OPERATING AT DESIGN CONDITIONS, AND IF THE EQUIPMENT HAS BEEN INSTALLED AND IS BEING OPERATED AND MAINTAINED IN ACCORDANCE WITH THE WRITTEN INSTRUCTIONS PROVIDED BY WATERSPROUT INC, WATERSPROUT INC. WILL REPAIR OR REPLACE AT ITS DISCRETION SUCH DEFECTIVE PARTS FREE OF CHARGE. DEFECTIVE PARTS MUST BE RETURNED BY OWNER TO WATERSPROUT INC. FACTORY POSTAGE PAID, IF SO REQUESTED. THE COST OF LABOR AND ALL OTHER EXPENSES RESULTING FROM REPLACEMENT OF THE DEFECTIVE PARTS AND FROM INSTALLATION OF PARTS FURNISHED UNDER THIS WARRANTY AND REGULAR MAINTENANCE ITEMS SUCH AS FILTERS SHALL BE BORNE BY THE OWNER. 2. THIS WARRANTY DOES NOT COVER GENERAL SYSTEM MISUSE OR ANY COMPONENTS THAT HAVE BEEN DISASSEMBLED BY UNAUTHORIZED PERSONS, IMPROPERLY INSTALLED OR DAMAGED DUE TO ALTERED OR IMPROPER WIRING OR OVERLOAD PROTECTION. 3. THIS WARRANTY APPLIES ONLY TO THE GREYWATER SYSTEM AND DOES NOT INCLUDE ANY OF THE STRUCTURE WIRING, PLUMBING, DRAINAGE, TANK OR DISPOSAL. 4. WATERSPROUT INC. RESERVES THE RIGHT TO REVISE, CHANGE OR MODIFY THE CONSTRUCTION AND/OR DESIGN OF THE GREYWATER SYSTEM, OR ANY COMPONENT PART OR PARTS THEREOF, WITHOUT INCURRING ANY OBLIGATION TO MAKE SUCH CHANGES OR MODIFICATIONS IN PRESENT EQUIPMENT. 5. WATERSPROUT INC. IS NOT RESPONSIBLE FOR CONSEQUENTIAL OR INCIDENTAL DAMAGES OF ANY NATURE RESULTING FROM SUCH THINGS AS, BUT NOT LIMITED TO, DEFECT IN DESIGN, MATERIAL, OR WORKMANSHIP, OR DELAYS IN DELIVERY, REPLACEMENTS OR REPAIRS. THIS WARRANTY IS IN LIEU OF ALL OTHER WARRANTIES EXPRESS OR IMPLIED. WATERSPROUT INC. SPECIFICALLY DISCLAIMS ANY IMPLIED WARRANTY OF MERCHANTABILITY OR FITNESS FOR A PARTICULAR PURPOSE. NO REPRESENTATIVE OR PERSON IS AUTHORIZED TO GIVE ANY OTHER WARRANTY OR TO ASSUME FOR WATERSPROUT INC.

 WATERLAB	
Commercial Greywater System GWC-1000U-20	
DRAWING NAME: SPECIFICATIONS	
DATE: 5/28/2016	DRAWN: JM
SCALE: NO SCALE	SHEET: 4 of 4
UNLESS NOTED DIMENSIONS ARE IN INCHES WITH TOLERANCES ±0.02 IN/IN DO NOT SCALE	
WATERLAB IS THE PRODUCTS DIVISION OF WATERSPROUT INC. THE INFORMATION CONTAINED IN THIS DRAWING IS THE SOLE PROPERTY OF WATERSPROUT INC. ANY REPRODUCTION IN PART OR AS A WHOLE WITHOUT THE WRITTEN PERMISSION OF WATERSPROUT INC IS PROHIBITED. DESIGN AND INVENTIONS RIGHTS ARE RESERVED. IN THE INTEREST OF TECHNOLOGICAL ADVANCEMENT, ALL PRODUCTS ARE SUBJECT TO DESIGN AND/OR MATERIAL CHANGE WITHOUT NOTICE WATERSPROUT INC. 2016	